

Article number: 20141B25B252BL

Description: E+G two-way connecting clamp
GN141-B25-B25-2-BL

Measures

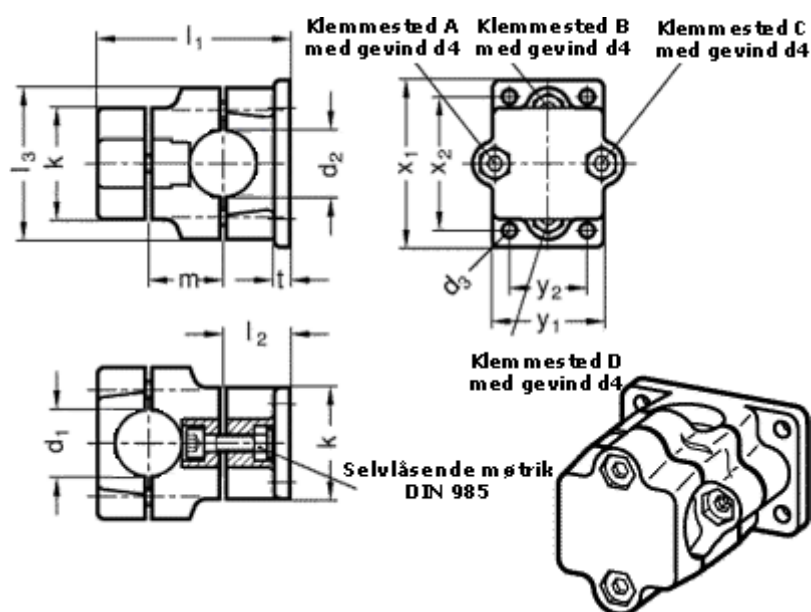

Adjustable clamp lever = GN 911-M 8-35 have to be ordred separately

d1	= 25
d2	= 25
d3	= 7
d4	= M 8
k	= 50
l1	= 89
l2	= 30

l3	= 68
m	= 36
t	= 7
x1	= 75
x2	= 60
y1	= 50
y2	= 35